

# 379 SERIES

## WET/DAMP LOCATIONS

DATE: \_\_\_\_\_ PROJECT MGR: \_\_\_\_\_

JOB: \_\_\_\_\_

PN: \_\_\_\_\_



### APPLICATIONS

Warehouses, Paper Mills  
 Parking Garages, Tunnels  
 Locker Rooms  
 Water Treatment Plants  
 Kitchens, Showers  
 Food Processing  
 Marinas/Offshore Facilities  
 Breweries and Bottling  
 Livestock Containment  
 Hospitals and Schools

The 379 Series is a perfect fixture for a multitude of applications desiring a wet/damp fixture or an enclosed high bay fixture. The 379 is a glass fiber reinforced product with injection molded lens options for precise detail and strength. The lenses also have frosted ends, lineal prism sides and an optically clear face for maximum photometric output. All hardware is stainless steel. The gear tray hinges at both sides with tool-less latches for ease of accessibility and maintenance. Ask us about our customized performance reflector option. Lamps not included.

### SPECIFICATIONS

**LISTINGS:** UL 1598 listed U.S. and Canada for wet locations  
 5 lamp: Tested for 270 watts @ 40° C  
 6 lamp: Tested for 378 watts @ 25° C  
 NSF: Splash zone non-food preparation  
 NEMA 4X  
 High pressure 1500 PSI tested  
 For information on the IP code see page 130.  
 For chemical resistance information see page 131.



**FEATURES:** Glass fiber reinforced polyester  
 5VA flammability rating  
 Suitable for outdoor and Indoor use  
 Closed cell polyurethane gasket with no seams  
 Standard V hook mounting

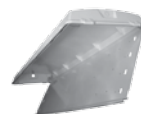

**LENS:** Impact resistant acrylic 91.5% transmission  
 Optional UV stabilized polycarbonate 87% transmission

**ELECTRICAL:** Available in 28, 32, 44, and 54 watts in T5, T8, T8HO, T5HO lamps.  
 Voltages of 120, 277, 347 and 480.

**OPTIONS:** ALL OPTIONS ORDERED SEPARATELY  
 Enhanced aluminum reflector  
 Emergency backup ballast  
 Cable mount - cable not included  
 Ceiling mount kit  
 Tamper resistant  
 Custom performance reflector (special request)

#### DIMENSIONS (Nominal)

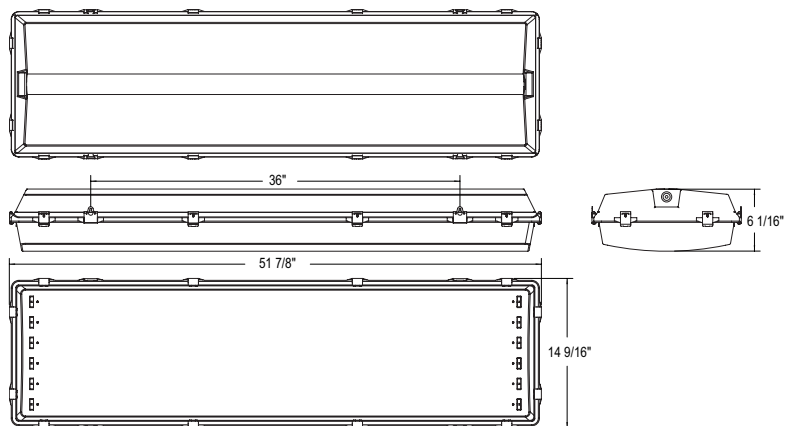

### WET/DAMP LOCATIONS



# 379 SERIES

## WET/DAMP LOCATIONS



www.ldpi-inc.com

379 SERIES	LAMP TYPE	LAMP QTY	LENGTH (Ft.)	VOLTAGE	LENS	OPTIONS
	T5: 28W T8: 32W* T8HO: 44W T5HO: 54W*	3L 4L* 5L 6L*	4	UNV1*: 120-277 Volts 50/60Hz 120: 120 Volts 60Hz 277: 277 Volts 60Hz UNV2: 347/480 Volts 50/60 Hz - T5HO ONLY	Diffuser Type: A: Acrylic* P: Polycarbonate	HB: Reflector EM: Emergency Backup Ballast CM: Cable Mount Cable not included TR: Tamper Resistant CR: Custom Performance Reflector System

\* Standard fixture configurations  
LAMPS SOLD SEPARATELY

### MOUNTING

Standard V-hook mounting

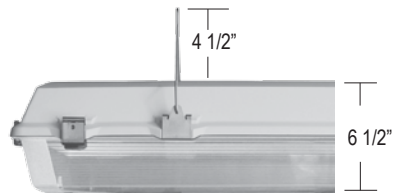
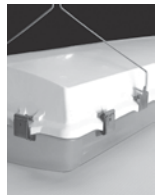

Stainless steel ceiling mount system

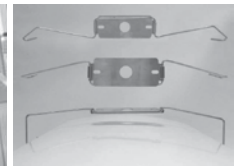

1 1/4" between ceiling and housing for heat dissipation  
Attaches directly to the ceiling!  
Mounting holes on the 6986 ceiling mount kit are 1/4" X 1/2" oval with a measurement of 4" on center.

Ceiling mount kit: 6986  
Kit consists of (2) 6985 brackets

### ADDITIONAL CEILING MOUNTS

Ceiling mount system kit: 8366:

Stainless steel ceiling mounting brackets, sealing washer, 1/2" conduit hub, 1/2" conduit hub plug and stainless steel support plate. (Assembly required)

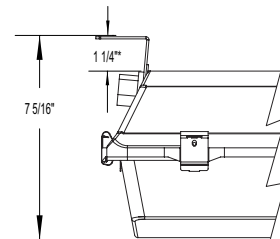
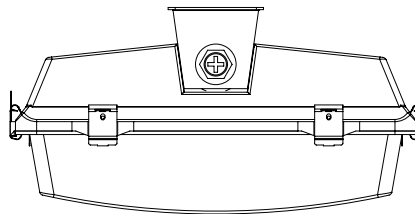
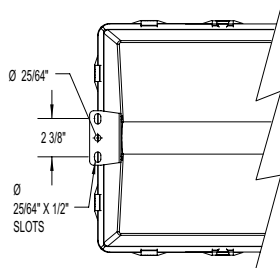

\*BETWEEN CEILING AND HOUSING FOR HEAT DISSIPATION

Ceiling mount system kit 8367 - Square bend U bolt

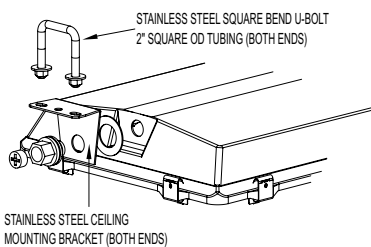

Ceiling mount system kit 8368 - U bolt

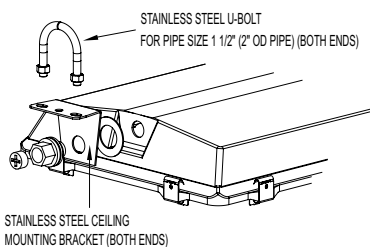

Ceiling mount system kit 8369 - 3 Ft. rod

